



# PRODUCT

USE INSTRUCTIONS

---



[ Technical support ]

**Ordering code: 00B933**

**Part number: FNI IOL-332-004-M12**

# IO-Link Hub module user manual

## 16xDI NPN

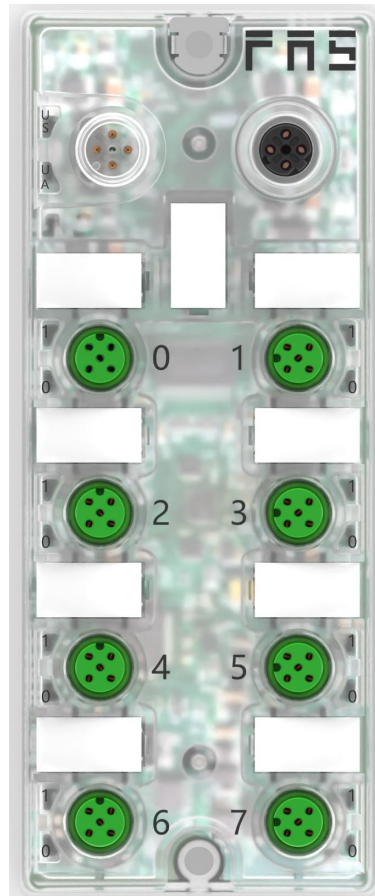

## Contents

Security .....	4
■ Expected use .....	4
■ Installation and start-up .....	4
■ Corrosion resistance .....	4
■ Dangerous voltage .....	4
■ General security .....	5
<b>1. Component function description .....</b>	<b>6</b>
1.1 Module overview .....	6
<b>2. Interface definition .....</b>	<b>7</b>
2.1 IO-Link interface .....	7
2.2 Expansion interface connection diagram .....	7
2.3 Digital input port connection diagram .....	8
2.4 Status LED meter .....	9
2.5 Mechanical dimensions .....	10
<b>3. IO-Link data .....</b>	<b>11</b>
3.1 Communication parameters .....	11
3.2 Process data .....	11
3.3 Electrical parameters .....	11
3.4 Service data .....	12
3.5 Error code .....	13
3.6 Event .....	13

## ■ Expected use

This manual describes as decentralized input and output modules for connecting to an industrial network.

---

## ■ Installation and start-up

Precautions!

Installation and start-up may only be performed by trained personnel. A qualified individual is one who is familiar with the installation and operation of the product and has the necessary qualifications to perform such operations. Any damage caused by unauthorized operation or illegal and improper use is not covered by the manufacturer's warranty. The equipment operator is responsible for ensuring that appropriate safety and accident prevention regulations are observed.

---

## ■ Corrosion resistance

Precautions!

FNI modules generally have good chemical and oil resistance. When used in corrosive media (e.g. high concentrations of chemicals, oils, lubricants, coolants and other material media (i.e. very low water content), these media must be checked before the corresponding application material compatibility. If a module fails or is damaged due to this corrosive medium, a defect claim cannot be made.

---

## ■ Dangerous voltage

Precautions!

Disconnect all power before using the device!

---

## ■ General security

Debugging and inspection	Trouble	Owner/operator obligations	Expected use
<p>Before debugging, read the user manual carefully.</p>	<p>If the defect or equipment failure cannot be corrected, the operation of the equipment must be stopped to avoid damage that may be caused by unauthorized use.</p>	<p>This equipment is an EMC Class A compliant product. This device produces RF noise.</p>	<p>The warranty and limited liability statement provided by the manufacturer does not cover damage caused by:</p> <ul style="list-style-type: none"> <li>·Unauthorized tampering</li> <li>·Improper use operation</li> </ul> <p>·The instructions provided in the user manual explain the use, installation and handling of discrepancies</p>
<p>This system cannot be used in an environment where the safety of personnel depends on the functionality of the equipment.</p>	<p>Only after the housing is fully installed can the intended use be assured.</p>	<p>The owner/operator must take appropriate precautions to use this equipment.</p> <p>This device can only use the power supply that matches this device, and can only connect cables approved for application.</p>	

# 1.Component function description

## 1.1 Module overview

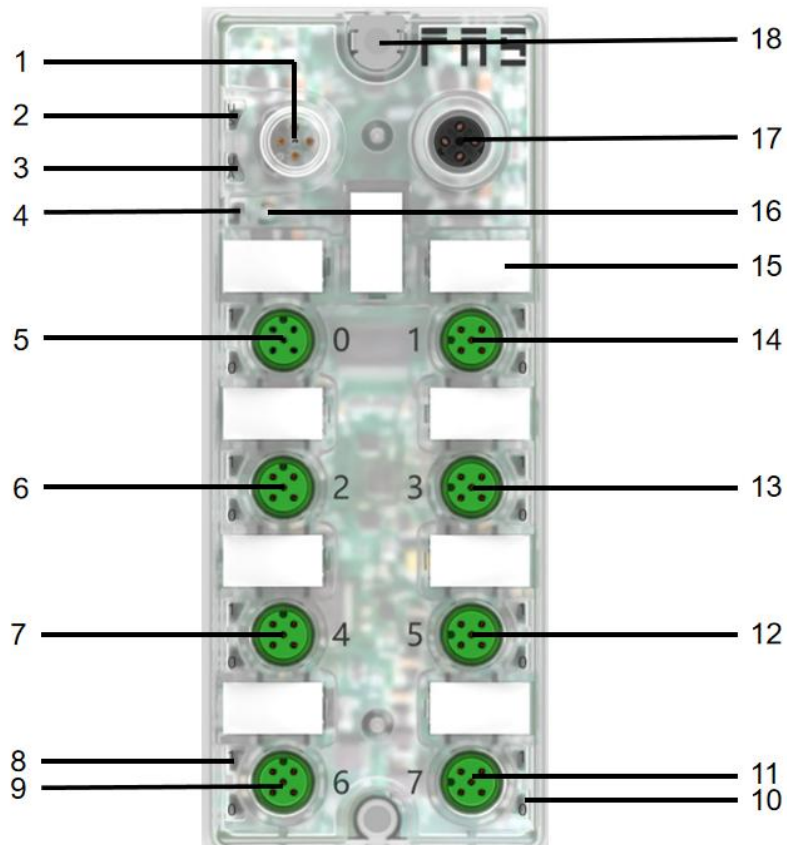

1	2	3	4	5	6
IO-Link interface	Status LED: Power	Status LED: Actuator	Status LED: IO-Link	Digital I/O port 0	Digital I/O port 2
7	8	9	10	11	12
Digital I/O port 4	Status LED: Digital I/O Port 6 Pin2	Digital I/O port 6	Status LED: Digital I/O port 7 Pin4	Digital I/O port 7	Digital I/O port 5
13	14	15	16	17	18
Digital I/O port 3	Digital I/O port 1	Label	Error status indicator	Extension ports	Earth interface

## 2.Interface definition

### 2.1 IO-Link interface

M12,A-Coded, Male

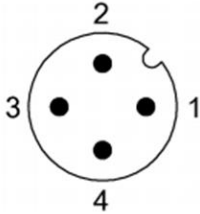

Pin	Illustrate
1	Power supply, +24 V
2	Actuator power supply, +24 V
3	GND
4	C/Q, IO-Link data transmission channel

### 2.2 Expansion interface connection diagram

M12,D-Coded, Female

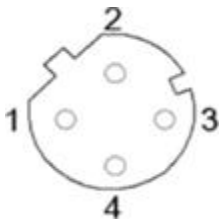

Pin	Illustrate
1	Voltage +24 V
2	C/Q1
3	GND
4	C/Q2

Extension notes:

1. The expansion port only allows modules of the same model
2. The expansion port of the next level module must be connected through the expansion port.
3. Common connection methods are as shown below.

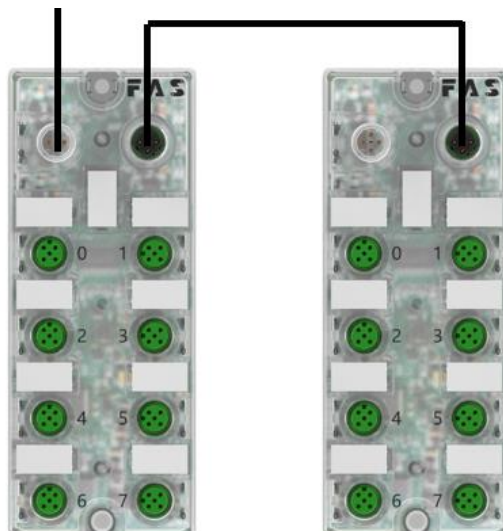

## 2.3 Digital input/output port connection diagram

M12,A-Coded,Female

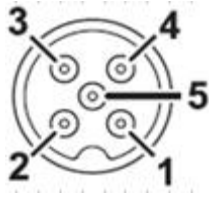

Pin	Function
1	24 V
2	Digital input (NPN)
3	0V,GND
4	Digital input (NPN)
5	FE

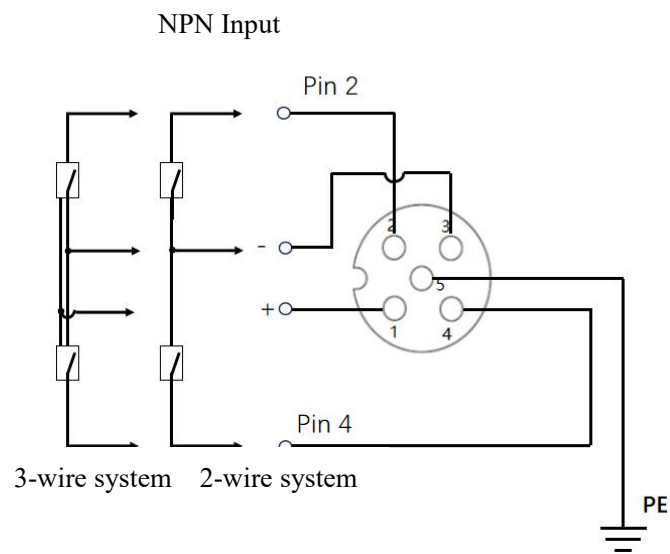



## 2.4 Status LED meter

State LED	State	Describe
US	Steady green	Module power supply is normal
	Destroy	Module is not powered
UA	Steady green	Auxiliary power supply is normal
	Destroy	No auxiliary power supply
COM	Green intermittent slow flash	Communication abnormality
	Green flashes intermittently quickly	Communication is normal
Error status indicator	Steady red	Auxiliary power supply abnormality
	Red flash	Auxiliary power supply voltage is too high (>DC30V)
	Flashing red slowly	Auxiliary power supply voltage is too low (<DC18V)
	Destroy	There is no exception in the module

## 2.5 Mechanical dimensions

Project	Specification
Dimensions (Width xHeight x Depth)	58MMx143.2MMx28.7MM

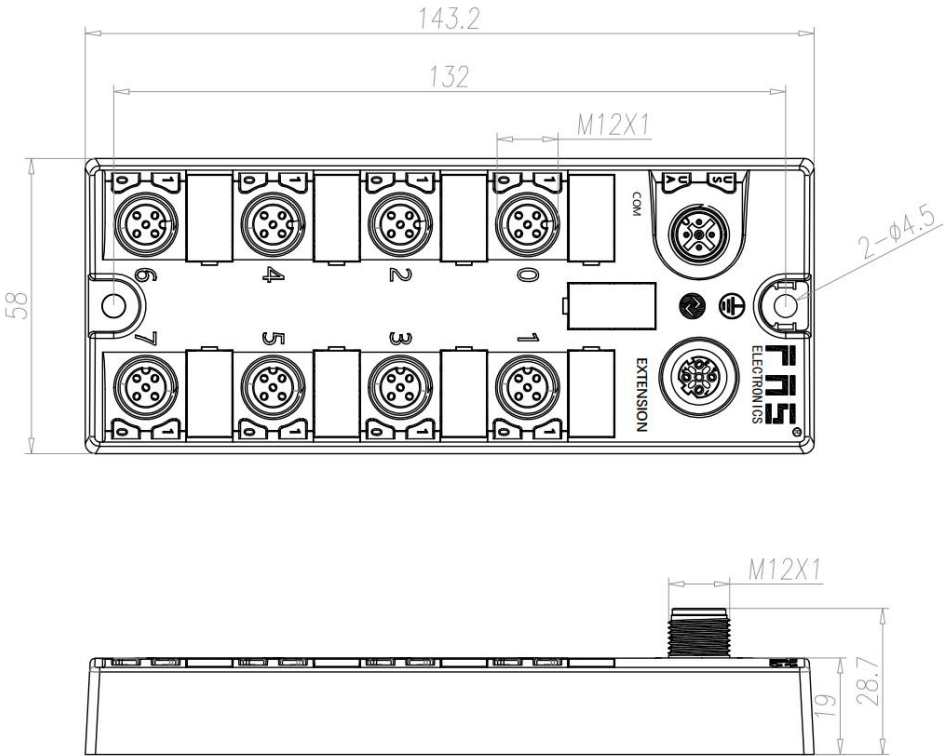

## 3.IO-Link data

### 3.1 Communication parameters

Data transmission baud rate	COM2 (38.4kbit/s)
Minimum cycle time	4.5ms
Process data cycle time	4.5ms,corresponds to the minimum cycle time
Process data length	4 bytes input

### 3.2 Process data

#### 3.2.1 Process data/input data

Note: (1) 0 and 1 are the first level, 2 and 3 are the second level (expansion)

(2) “输入端口”Translate“ Input port”.

Byte	0								1							
Bits	7	6	5	4	3	2	1	0	7	6	5	4	3	2	1	0
PIN	输入端口 7 P I N 4	输入端口 6 P I N 4	输入端口 5 P I N 4	输入端口 4 P I N 4	输入端口 3 P I N 4	输入端口 2 P I N 4	输入端口 1 P I N 4	输入端口 0 P I N 4	输入端口 7 P I N 2	输入端口 6 P I N 2	输入端口 5 P I N 2	输入端口 4 P I N 2	输入端口 3 P I N 2	输入端口 2 P I N 2	输入端口 1 P I N 2	输入端口 0 P I N 2
Byte	2								3							
Bits	7	6	5	4	3	2	1	0	7	6	5	4	3	2	1	0
PIN	输入端口 7 P I N 4	输入端口 6 P I N 4	输入端口 5 P I N 4	输入端口 4 P I N 4	输入端口 3 P I N 4	输入端口 2 P I N 4	输入端口 1 P I N 4	输入端口 0 P I N 4	输入端口 7 P I N 2	输入端口 6 P I N 2	输入端口 5 P I N 2	输入端口 4 P I N 2	输入端口 3 P I N 2	输入端口 2 P I N 2	输入端口 1 P I N 2	输入端口 0 P I N 2

### 3.3 Electrical parameters

Rated working voltage	18...30V DC
Maximum current of each port (Pin1)	1A
Total current Us	<1.4A
Total current Ua	<2A

### 3.4 Service data

	DPP	SPDU		Object name	length	Scope	Defaults
	Index	Index	Subindex				
Identification data				Supplier ID	2		0x0454
				Device ID	3		0x099EE1
		0x10	0	Supplier name	19	Read only	FAS(Fujian)Co.,LTD
		0x11	0	Supplier text	16		<a href="http://www.fas-elec.com">www.fas-elec.com</a>
		0x12	0	Product name	19		FNI IOL-332-004-M12
		0x13	0	Product ID	6		00B933
		0x14	0	Product text	44		IO-Link M12 NPN extended with other
		0x16	0	Hardware version	3		20220323
	0x17	0	Firmware version	3	2.02		
Parameter data		0x40	0	Bit reversal	4	00000000-FFFFFFFF	0x00000000
		0x41	0	Direction	4	00000000-FFFFFFFF	0x00000000
		0x55	0	Equipment type	1	0x01	0x01

**Note:**

0x40 setting bit inversion: 0-bit is not inverted, 1-bit is inverted. For example, the external input is 0x0000. When 0x40 is 0x00000000, the value is 0x00000000 (not inverted). When 0x40 is 0xFFFFFFFF, the value is 0xFFFFFFFF (inverted).

0x41 sets the direction: 0-input, 1-output.

### 3.5 Error code

Error code	Additional code
Device application error 0x80	Index not available 0x11
	Subindex not available 0x12
	Value out of range 0x30

### 3.6 Event

Class/qualifier			Code (high + low)			
Model	Type	Example				
Appear	Mistake	AL	Device hardware	Powered by	Power supply low voltage	U2=Powered by+24V
0xC0	0x30	0x03	0x5000	0x0100	0x0010	0x0002
0xF3			0x5112			
Disappear	Mistake	AL	Device hardware	Powered by	Power supply low voltage	U2=Powered by+24V
0x80	0x30	0x03	0x5000	0x0100	0x0010	0x0002
0xB3			0x5112			
Appear	Mistake	AL	Device hardware	Powered by	Power supply for peripherals	
0xC0	0x30	0x03	0x5000	0x0100	0x0060	
0xF3			0x5160			
Disappear	Mistake	AL	Device hardware	Powered by	Power supply for peripherals	
0x80	0x30	0x03	0x5000	0x0100	0x0060	
0xB3			0x5160			

High quality products · Sincere service



[ Technical support ]



[ Official website ]



Telephone : 0591-22991876

Technical support : +86 13306936805

Official website: [www.faselec.com](http://www.faselec.com)

Business support : +86 19905006938

Address: Room 009, A1, Building 1, National University Science and Technology  
Park Science and Technology Innovation Center, No. 6 Qiuyang East Road,  
Shangjie Town, Minhou County, Fujian Province.